

Grizzly **Industrial, Inc.**®

DRUM / FLAP SANDER MODEL G0518 INSTRUCTION MANUAL



COPYRIGHT © JANUARY 2003 BY GRIZZLY INDUSTRIAL, INC
**WARNING: NO PORTION OF THIS MANUAL MAY BE REPRODUCED IN ANY SHAPE
OR FORM WITHOUT THE WRITTEN APPROVAL OF GRIZZLY INDUSTRIAL, INC.**
PRINTED IN TAIWAN

ONLINE MANUAL DISCLAIMER

THE INFORMATION IN THIS MANUAL REPRESENTS THE CONFIGURATION OF THE MACHINE AS IT IS CURRENTLY BEING SHIPPED. THE MACHINE CONFIGURATION CAN CHANGE AS PRODUCT IMPROVEMENTS ARE INCORPORATED. IF YOU OWN AN EARLIER VERSION OF THE MACHINE, THIS MANUAL MAY NOT EXACTLY DEPICT YOUR MACHINE. CONTACT CUSTOMER SERVICE IF YOU HAVE ANY QUESTIONS ABOUT DIFFERENCES. PREVIOUS VERSIONS ARE NOT AVAILABLE ONLINE.

WARNING

Some dust created by power sanding, sawing, grinding, drilling, and other construction activities contains chemicals known to the State of California to cause cancer, birth defects or other reproductive harm. Some examples of these chemicals are:

- Lead from lead-based paints.
- Crystalline silica from bricks, cement, and other masonry products.
- Arsenic and chromium from chemically treated lumber.

Your risk from these exposures varies, depending on how often you do this type of work. To reduce your exposure to these chemicals: work in a well ventilated area, and work with approved safety equipment, such as those dust masks that are specially designed to filter out microscopic particles.

TABLE OF CONTENTS

	PAGE
1. SAFETY	2
Safety Instructions For Power Tools	2-3
Safety Instructions For Drum / Flap Sanders	4
2. INTRODUCTION	5
Commentary	5
3. CIRCUIT REQUIREMENTS	6
110V Operation	6
220V Operation	7
Grounding	8
Extension Cords	8
4. MACHINE FEATURES.....	9
5. SET UP.....	10
Unpacking	10
Piece Inventory.....	10-11
Hardware Recognition Chart.....	12
Clean Up	13
Site Considerations	13
Beginning Assembly	14
Stand To Base.....	14
Motor To Stand	15
Dust Hood Brackets	15
Dust Hoods	16
Acrylic Eye Shields	16
Sanding Drum	17
Flap Sander	18-19
Dust Collection	19
Start Up	20
6. OPERATION.....	21
Operation Safety	21
Choosing Sandpaper.....	21
Drum Sanding	22
Flap Sanding	23
7. MAINTENANCE	24
Maintenance Safety.....	24
General	24
8. SERVICE ADJUSTMENTS	25
Flap Sander	25
Changing Motor Voltage	26
9. REFERENCE INFO	27
Data Sheet.....	28
Parts Diagram And List	29-32
Aftermarket Accessories	33
Warranty And Returns	34-36

SECTION 1: SAFETY

WARNING

For Your Own Safety Read Instruction Manual Before Operating This Equipment

The purpose of safety symbols is to attract your attention to possible hazardous conditions. This manual uses a series of symbols and signal words which are intended to convey the level of importance of the safety messages. The progression of symbols is described below. Remember that safety messages by themselves do not eliminate danger and are not a substitute for proper accident prevention measures.



Indicates an imminently hazardous situation which, if not avoided, WILL result in death or serious injury.



Indicates a potentially hazardous situation which, if not avoided, COULD result in death or serious injury.



Indicates a potentially hazardous situation which, if not avoided, MAY result in minor or moderate injury. It may also be used to alert against unsafe practices.

NOTICE

This symbol is used to alert the user to useful information about proper operation of the equipment.

WARNING

Safety Instructions For Power Tools

1. **KEEP GUARDS IN PLACE** and in working order.
2. **REMOVE ADJUSTING KEYS AND WRENCHES.** Form habit of checking to see that keys and adjusting wrenches are removed from tool before turning on.
3. **KEEP WORK AREA CLEAN.** Cluttered areas and benches invite accidents.
4. **NEVER USE IN DANGEROUS ENVIRONMENT.** DO NOT use power tools in damp or wet locations, or where any flammable or noxious fumes may exist. Keep work area well lighted.
5. **KEEP CHILDREN AND VISITORS AWAY.** All children and visitors should be kept at a safe distance from work area.
6. **MAKE WORKSHOP CHILD PROOF** with padlocks, master switches, or by removing starter keys.
7. **NEVER FORCE TOOL.** It will do the job better and safer at the rate for which it was designed.
8. **USE RIGHT TOOL.** DO NOT force tool or attachment to do a job for which it was not designed.

WARNING

Safety Instructions For Power Tools

- 9. USE PROPER EXTENSION CORD.** Make sure your extension cord is in good condition. Conductor size should be in accordance with the chart below. The amperage rating should be listed on the motor or tool nameplate. An undersized cord will cause a drop in line voltage resulting in loss of power and overheating. Your extension cord must also contain a ground wire and plug pin. Always repair or replace extension cords if they become damaged.

Minimum Gauge for Extension Cords

AMP RATING	LENGTH		
	25ft	50ft	100ft
0-6	16	16	16
7-10	16	16	14
11-12	16	16	14
13-16	14	12	12
17-20	12	12	10
21-30	10	10	No

- 10. WEAR PROPER APPAREL.** DO NOT wear loose clothing, gloves, neckties, rings, bracelets, or other jewelry which may get caught in moving parts. Non-slip footwear is recommended. Wear protective hair covering to contain long hair.
- 11. ALWAYS USE SAFETY GLASSES.** Also use face or dust mask if cutting operation is dusty. Everyday eyeglasses only have impact resistant lenses, they are NOT safety glasses.
- 12. SECURE WORK.** Use clamps or a vise to hold work when practical. It's safer than using your hand and frees both hands to operate tool.
- 13. DO NOT OVER-REACH.** Keep proper footing and balance at all times.
- 14. MAINTAIN TOOLS WITH CARE.** Keep tools sharp and clean for best and safest performance. Follow instructions for lubricating and changing accessories.

- 15. USE RECOMMENDED ACCESSORIES.** Consult the owner's manual for recommended accessories. The use of improper accessories may cause risk of injury.

- 16. REDUCE THE RISK OF UNINTENTIONAL STARTING.** On machines with magnetic contact starting switches there is a risk of starting if the machine is bumped or jarred. Always disconnect from power source before adjusting or servicing. Make sure switch is in OFF position before reconnecting.

- 17. CHECK DAMAGED PARTS.** Before further use of the tool, a guard or other part that is damaged should be carefully checked to determine that it will operate properly and perform its intended function. Check for alignment of moving parts, binding of moving parts, breakage of parts, mounting, and any other conditions that may affect its operation. A guard or other part that is damaged should be properly repaired or replaced.

- 18. NEVER LEAVE TOOL RUNNING UNATTENDED. TURN POWER OFF.** DO NOT leave tool until it comes to a complete stop.

- 19. NEVER OPERATE A MACHINE WHEN TIRED, OR UNDER THE INFLUENCE OF DRUGS OR ALCOHOL.** Full mental alertness is required at all times when running a machine.

- 20. NEVER ALLOW UNSUPERVISED OR UNTRAINED PERSONNEL TO OPERATE THE MACHINE.** Make sure any instructions you give in regards to machine operation are approved, correct, safe, and clearly understood.

- 21. IF AT ANY TIME YOU ARE EXPERIENCING DIFFICULTIES** performing the intended operation, stop using the machine! Then contact our service department or ask a qualified expert how the operation should be performed.

WARNING

Safety Instructions For Drum / Flap Sanders

1. **BE AWARE OF DRUM OR FLAP ATTACHMENT ROTATION DIRECTION** when sanding.
2. **KEEP FINGERTIPS AWAY FROM MOVING PARTS.**
3. **NEVER USE EXCESSIVE FORCE WHEN SANDING.** Doing so greatly increases the chance of personal injury, mechanical damage, or damage to your workpiece.
4. **ALWAYS FEED YOUR WORKPIECE AGAINST THE DIRECTION OF ROTATION.**
5. **DEVELOP GOOD HABITS IN YOUR SHOP** and safety will become second-nature to you. Habits – good and bad – are hard to break.
6. **DO NOT SAND A WORKPIECE IF YOU DOUBT ITS STABILITY OR INTEGRITY.** Inspect all materials carefully for foreign objects like nails and staples.
7. **WHEN DRUM SANDING, FEED MATERIAL INTO THE PORTION OF THE DRUM SPINNING DOWNWARD.**
8. **PROLONGED EXPOSURE TO WOOD DUST IS KNOWN TO CAUSE CANCER IN HUMANS.** Always wear an OSHA-approved respirator when working in an environment that could contain wood dust.
9. **DO NOT OPERATE THE SANDER IF THE DRUM OR FLAP ATTACHMENT IS DAMAGED OR BADLY WORN.** Pieces of sandpaper could be ejected from the sander, causing serious injury.

CAUTION

No list of safety guidelines can be complete. Every shop environment is different. Always consider safety first, as it applies to your individual working conditions. Use this and other machinery with caution and respect. Failure to do so could result in serious personal injury, damage to equipment or poor work results.

WARNING

Like all power tools, there is danger associated with the Model G0518. Accidents are frequently caused by lack of familiarity or failure to pay attention. Use this tool with respect and caution to lessen the possibility of operator injury. If normal safety precautions are overlooked or ignored, serious personal injury may occur.

SECTION 2: INTRODUCTION

Commentary

We are proud to offer the Grizzly Model G0518 Drum / Flap Sander. The Model G0518 is part of a growing Grizzly family of fine woodworking machinery. When used according to the guidelines set forth in this manual, you can expect years of trouble-free, enjoyable operation and proof of Grizzly's commitment to customer satisfaction.

Grizzly is also pleased to provide this manual with the Model G0518. It was written to guide you through the assembly, review the safety considerations, and cover the general operating procedures. If you have any comments regarding this manual, please write to us at the address below:

Grizzly Industrial, Inc.
c/o Technical Documentation
P.O. Box 2069
Bellingham, WA 98227-2069

Most importantly, we stand behind our machines. If you have any service questions or parts requests, please call or write us at the location listed below:

Grizzly Industrial, Inc.
1203 Lycoming Mall Circle
Muncy, PA 17756
Phone: (570) 546-9663
Fax: (800) 438-5901
E-Mail: techsupport@grizzly.com
Web Site: <http://www.grizzly.com>

The specifications, drawings, and photographs illustrated in this manual represent the Model G0518 as supplied when the manual was prepared. However, owing to Grizzly's policy of continuous improvement, changes may be made at any time with no obligation on the part of Grizzly. Current Grizzly machine manuals can be viewed and printed at: www.grizzly.com.

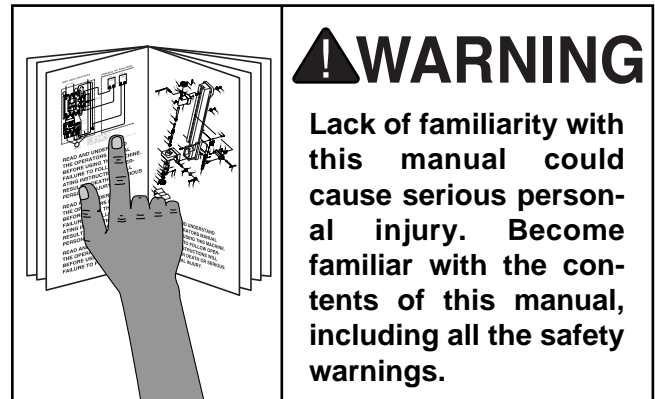

SECTION 3: CIRCUIT REQUIREMENTS

110V Operation

Amperage Draw

The Model G0518 is prewired to operate at 110V, with an amperage draw of approximately 12A.

Plug Type

The Model G0518 is supplied with a NEMA 5-15 plug. DO NOT modify the plug or power cord in any way. See **Figure 1** for a NEMA 5-15 plug and grounded outlet.

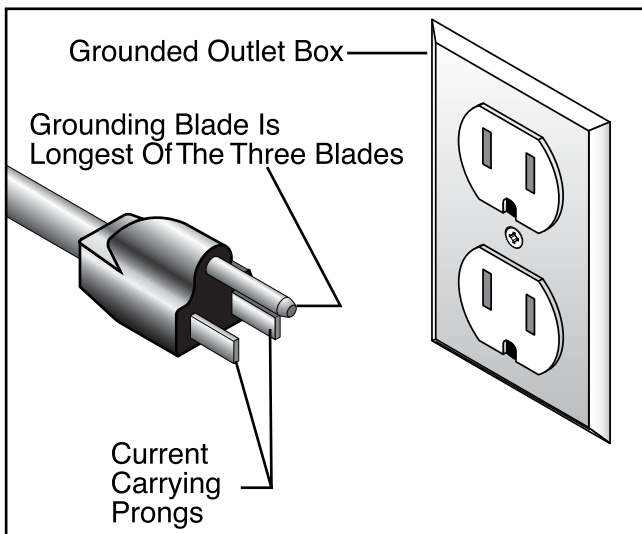

Figure 1. NEMA 5-15 plug and grounded outlet.

Circuit Breaker Requirements

We recommend operating the machine on a dedicated circuit. Because the machine draws 12A when operated at 110V, use a 15A circuit breaker. Circuit breakers rated any higher are not adequate to protect the circuit from overheating and fire.

Your Circuit Capacity

Always check to see if the wires in your circuit are capable of handling the amperage draw from your machine, as well as any other machines that could be operating on the same circuit. If you are unsure, consult a qualified electrician.

If the circuit breaker trips or the fuse blows regularly, your machine may be operating on a circuit that is close to its amperage draw capacity. However, if an unusual amperage draw does not exist and a power failure still occurs, contact a qualified electrician or our service department.

⚠️ WARNING

Serious personal injury could occur if you connect your machine to the power source before you have completed the assembly process. DO NOT connect the machine to the power source until instructed to do so.



220V Operation

NOTICE

If a 220V power source will be used, rewire the power switch before assembling the motor to the stand. See Page 26 for complete instructions on rewiring the sander.

Amperage Draw

The Model G0518 can be rewired to operate at 220V, with an amperage draw of approximately 6A.

Plug Type

If the Model G0518 is rewired to operate at 220V, the existing plug must be replaced with a NEMA 6-15 plug. A suitable 220V power source must be used along with a properly grounded outlet. See **Figure 1** for a NEMA 6-15 plug and grounded outlet.

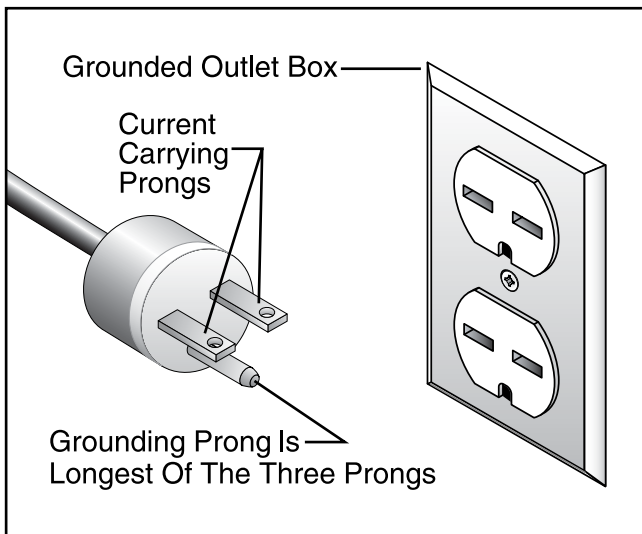

Figure 2. NEMA 6-15 plug and grounded outlet.

Circuit Breaker Requirements

We recommend operating the machine on a dedicated circuit. Because the machine draws 6A when operated at 220V, use a 10A double-pole circuit breaker. Circuit breakers rated any higher are not adequate to protect the circuit from overheating and fire.

Your Circuit Capacity

Always check to see if the wires in your circuit are capable of handling the amperage draw from your machine, as well as any other machines that could be operating on the same circuit. If you are unsure, consult a qualified electrician.

If the circuit breaker trips or the fuse blows regularly, your machine may be operating on a circuit that is close to its amperage draw capacity. However, if an unusual amperage draw does not exist and a power failure still occurs, contact a qualified electrician or our service department.

⚠ WARNING

Serious personal injury could occur if you connect your machine to the power source before you have completed the assembly process. DO NOT connect the machine to the power source until instructed to do so.



Grounding

In the event of an electrical short, grounding reduces the risk of electric shock by providing a path of least resistance to disperse electric current. This machine is equipped with a power cord that has an equipment-grounding prong. The outlet must be properly installed and grounded in accordance with all local codes and ordinances.

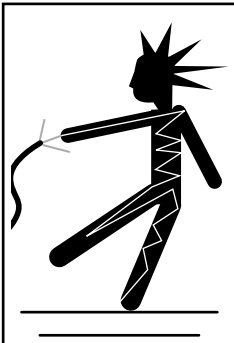

!WARNING

Electrocution or a fire can result if the machine is not grounded correctly. Make sure all electrical circuits are grounded. Do not use the machine if it is not grounded.

NOTICE

The wire on the power cord with green or green and yellow striped insulation is the grounding conductor.

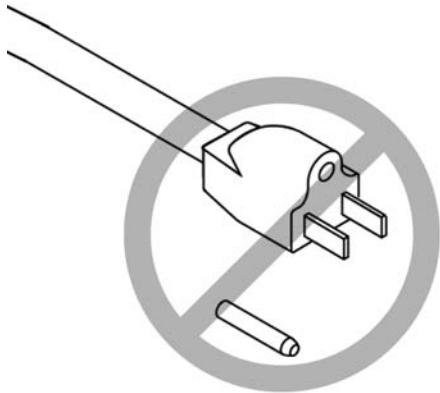

!CAUTION

This machine must have a ground prong in the plug to help ensure that it is grounded. DO NOT remove ground prong from plug to fit into a two-pronged outlet! If the plug will not fit the outlet, have the proper outlet installed by a qualified electrician.



Extension Cord

If you find it absolutely necessary to use an extension cord while operating this machine on a 110V power source:

- Make sure the cord is rated for Standard Service (Grade S) or better.
- The extension cord must also contain a ground wire and plug pin.
- Use a 16 gauge cord if the cord is 50 feet long or less.
- Use a 14 gauge cord if the cord is between 50 and 100 feet long.

We do not recommend the use of extension cords on 220V equipment. Instead, arrange the placement of your equipment and the installed wiring to eliminate the need for extension cords.

If you find it absolutely necessary to use an extension cord while operating this machine on a 220V power source:

- Make sure the cord is rated for Standard Service (Grade S) or better.
- The extension cord must also contain a ground wire and plug pin.
- Use at least a 16 gauge cord if the cord is 100 feet long or less.



!CAUTION

No single list of electrical guidelines can be comprehensive for all shop environments. Operating this machinery may require additional electrical upgrades specific to your machine and shop environment. It is your responsibility to make sure your electrical systems comply with all local electrical codes and ordinances.

SECTION 4: MACHINE FEATURES

Set up and operation instructions will be easier to understand if you become familiar with the location and names of the basic features of the sander (**Figure 3**).

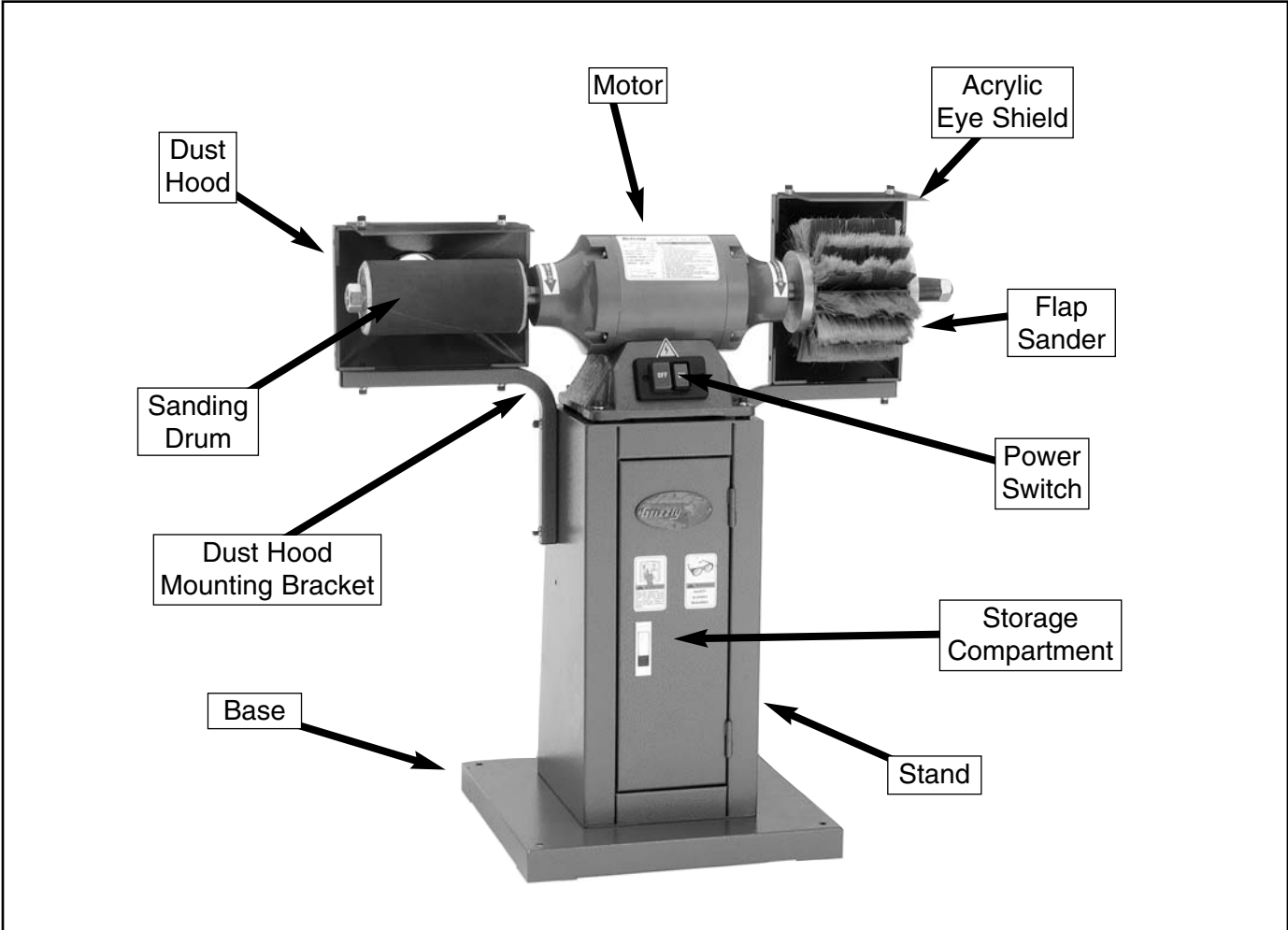



Figure 3. Front view of sander.



SECTION 5: SET UP

Unpacking

The Model G0518 Drum / Flap Sander is shipped from the manufacturer in three carefully packed boxes. If any of the boxes are damaged after you have signed for delivery, immediately call our customer service for advice.

	<p>⚠️ WARNING</p> <p>The Model G0518 is a heavy machine, weighing 155 lbs. Personal injury could occur if the machine is moved without additional assistance. Seek the help of friends when moving or lifting the machine.</p>
---	---

Piece Inventory

When you are completely satisfied with the condition of the shipment, you should inventory its parts (**Figure 4**).

	<p>⚠️ CAUTION</p> <p>Sharp edges on metal parts may cause personal injury. Examine the edges of all metal parts before handling.</p>
--	---



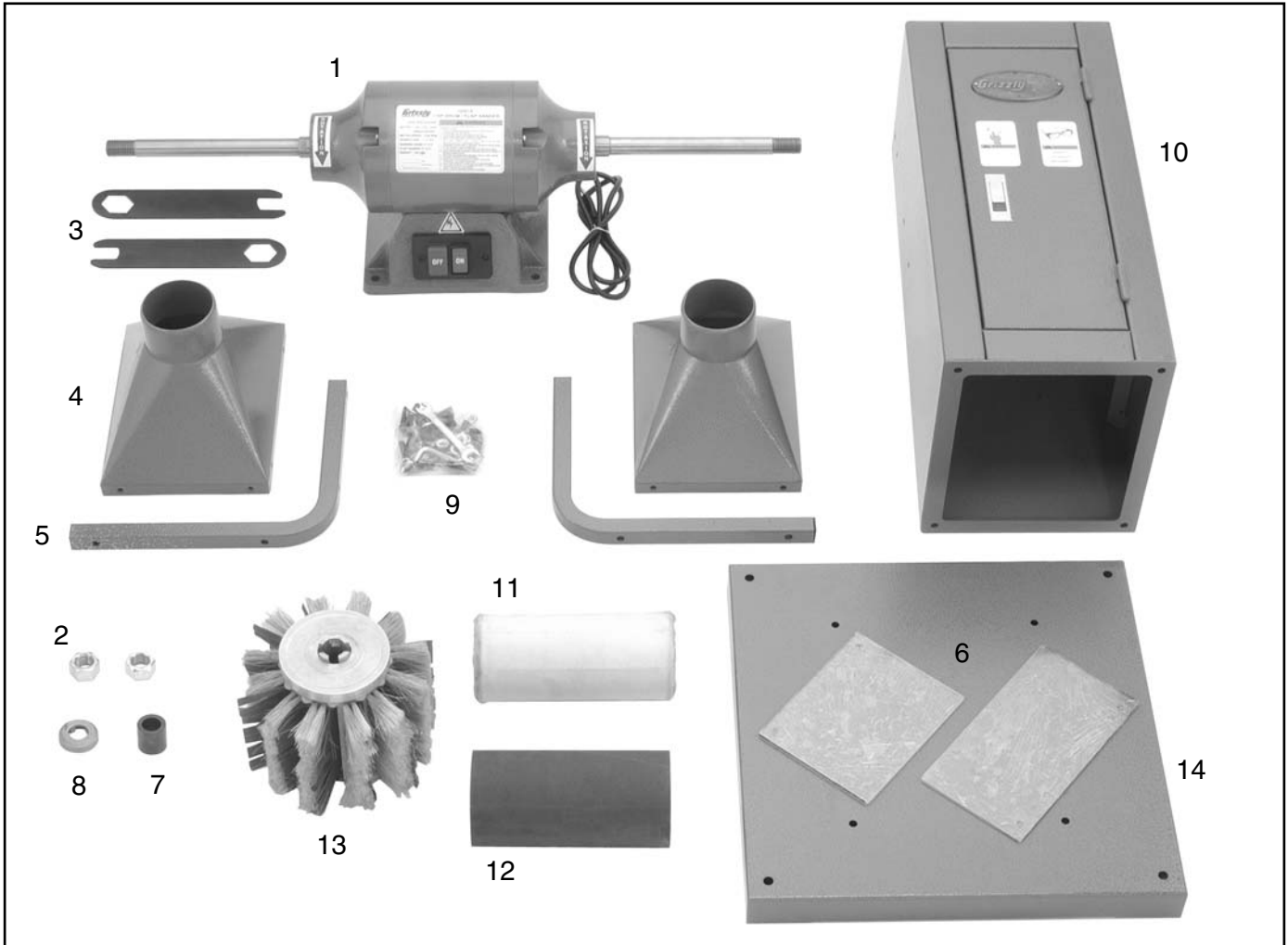

Figure 4. Model G0518 component layout.

Box 1 of 3:

1. Motor	Qty	1
2. Arbor Nuts	2	
3. Arbor Wrenches	2	
4. Dust Hoods	2	
5. Dust Hood Supports	2	
6. Acrylic Eye Shields	2	
7. Arbor Spacer	1	
8. Flange	1	
9. Hardware Bag	1	
–Cap Screws M8-1.25 x 20	8	
–Hex Flange Nuts M8-1.25	8	
–Flat Washers 8MM	20	
–Lock Washers 8MM	20	
–Cap Screws M8-1.25 x 40	12	
–Open-End Wrench 13MM	1	
–Allen Wrench 6MM	1	

Box 2 of 3:

10. Stand	Qty	1
11. Sanding Drum	1	
12. Sandpaper Sleeve 4"D x 9"W	1	
13. Flap Sander	1	

Box 3 of 3:

14. Stand Base	Qty	1
----------------	-----	---



Hardware Recognition Chart

Use this chart to match up hardware pieces during the assembly process!

MEASURE BOLT DIAMETER BY PLACING INSIDE CIRCLE

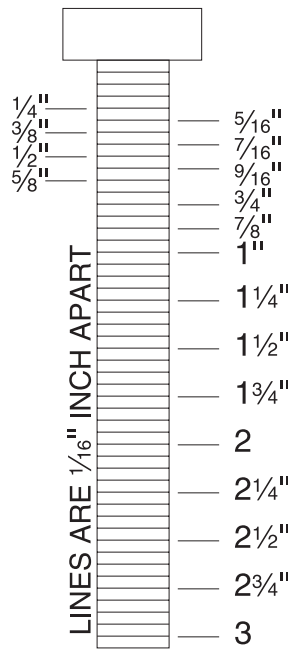
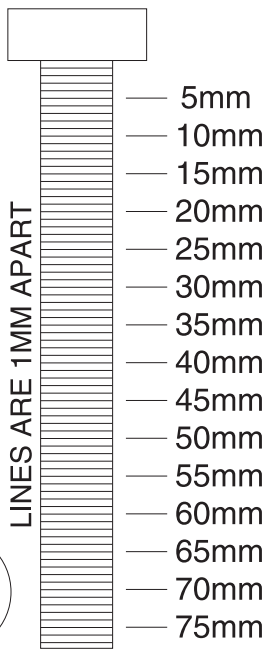
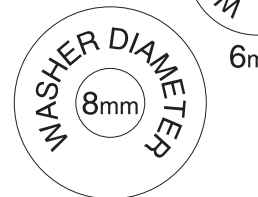
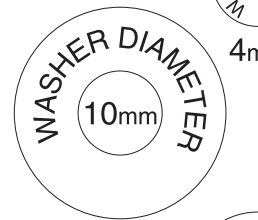
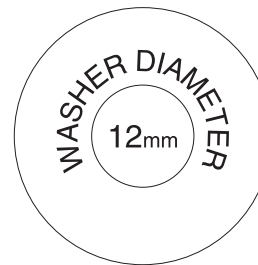
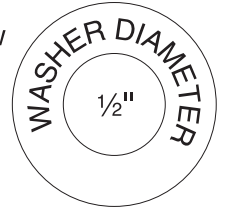
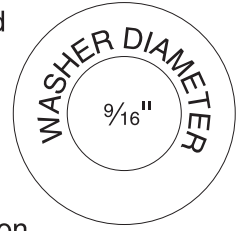
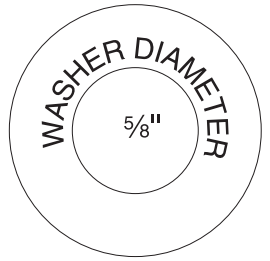
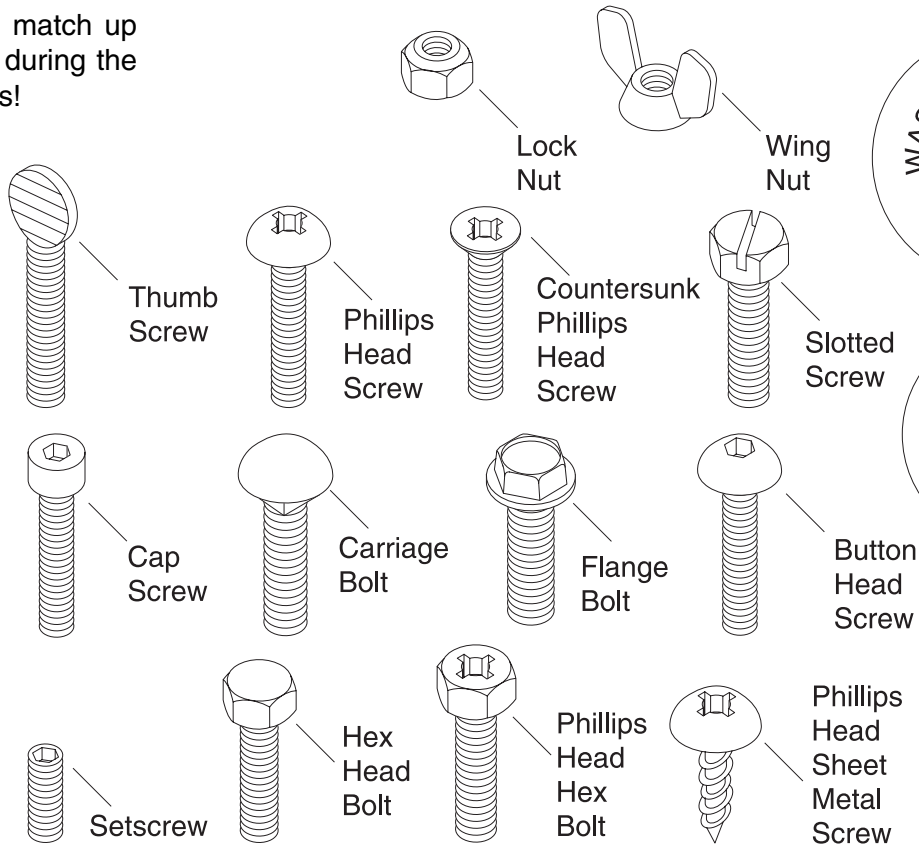
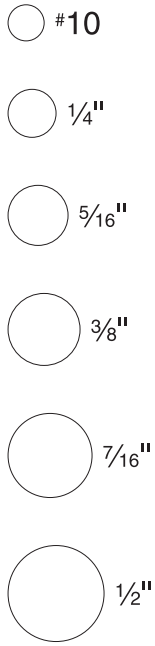

WASHERS ARE MEASURED BY THE INSIDE DIAMETER

Clean Up

Unpainted surfaces may be coated with a waxy oil to protect them from corrosion during shipment. Remove this waxy oil with a solvent cleaner or citrus-based degreaser such as Grizzly's G7895 Degreaser. To clean thoroughly, some parts may need to be removed. **The machine will operate best when the waxy oil is removed from all moving and sliding parts.** Chlorine-based cleaners and solvents will damage the painted surfaces of the machine. Follow the manufacturer's instructions when using any type of cleaning product.

	!WARNING Gasoline and petroleum products have low flash points and could explode if used to clean machinery. DO NOT use gasoline or petroleum products to clean the machinery.
--	---

	!WARNING Smoking near solvents could ignite an explosion or fire and cause serious injury. DO NOT smoke while using solvents.
---	--

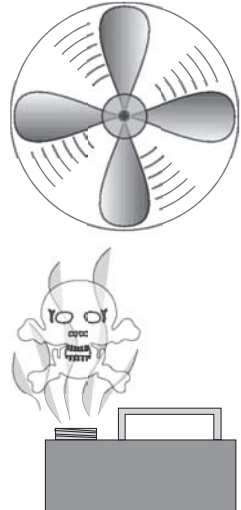
	!WARNING Lack of ventilation while using solvents could cause serious personal health risks, fire, or environmental hazards. Always work in a well ventilated area to prevent the accumulation of dangerous fumes. Supply the work area with a constant source of fresh air.
---	--



Site Considerations

Weight Load

The Model G0518 is a medium weight load with a small footprint. Most shop floors should be sufficient to carry the weight of the machine. Reinforce the floor if you question its ability to support the weight.

Working Clearance

Working clearances can be thought of as the distances between machines and obstacles that allow safe operation of every machine without limitation. Consider existing and anticipated machine needs, size of material to be processed through each machine, and space for auxiliary stands and/or work tables. Also consider the relative position of each machine to one another for efficient material handling.

Lighting And Outlets

Lighting should be bright enough to eliminate shadow and prevent eye strain. Electrical circuits should be dedicated or large enough to handle the amperage draw. Outlets should be located near each machine so power or extension cords are clear of high-traffic areas. Observe local electrical codes for proper installation of new lighting, outlets, or circuits.

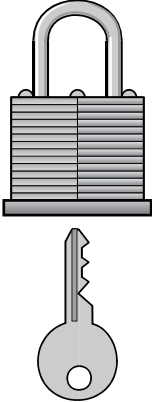
	!WARNING Unsupervised children and visitors inside your shop could receive serious personal injury. Ensure child and visitor safety by keeping all entrances to the shop locked at all times. DO NOT allow unsupervised children or visitors in the shop at any time.
--	--





Beginning Assembly

This section will cover the basic assembly and adjustment instructions needed to begin operation. Complete the assembly in the order provided in this manual and then read the remaining portion of the manual before attempting any type of operation.

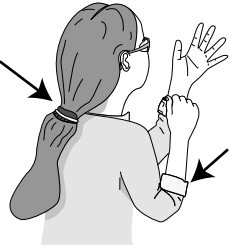
Your safety is important! Please follow the warnings below during this entire section:

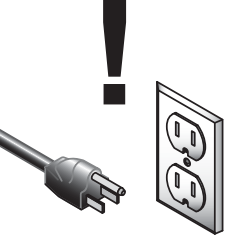
	<p>⚠ WARNING</p> <p>Loose hair and clothing could get caught in machinery and cause serious personal injury. Keep loose clothing rolled up and long hair tied up and away from machinery.</p>
---	--

	<p>⚠ WARNING</p> <p>Serious personal injury could occur if you connect your machine to the power source before you have completed the assembly process. DO NOT connect the machine to the power source until instructed to do so.</p>
---	---

	<p>⚠ CAUTION</p> <p>Sharp edges on metal parts may cause personal injury. Examine the edges of all metal parts before handling.</p>
---	--



Stand To Base

To attach the stand to the base:

Attach the stand to the base with (4) M8-1.25 x 20 cap screws, (4) M8 flat washers, (4) M8 lock washers and (4) M8-1.25 hex flange nuts (**Figure 5**). Note—*The lock washers should be installed between the flat washers and the head of the cap screws.*

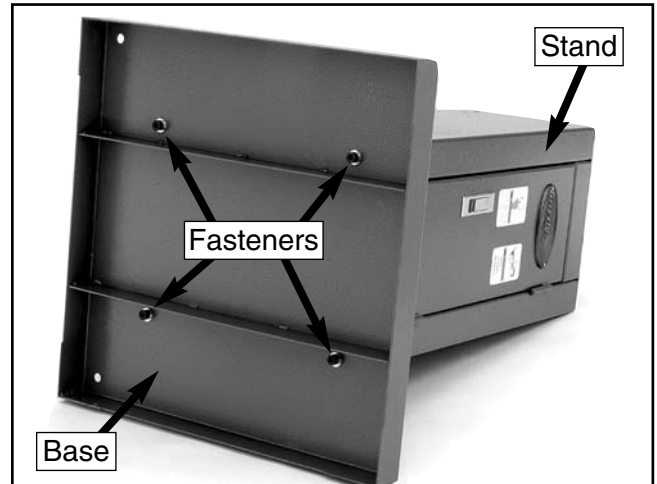

Figure 5. Stand attached to base.



Motor To Stand

NOTICE

If you intend to operate the Model G0518 at 220V, rewire it before continuing. See Page 26 for complete instruction on rewiring the sander.

To attach the motor to the stand:

Attach the motor to the stand with (4) M8-1.25 x 20 cap screws, (4) M8 flat washers, (4) M8 lock washers, (4) plastic disc pads and (4) M8-1.25 hex flange nuts (**Figure 6**). Note—*The plastic disc pads should be installed between the motor and the stand.*

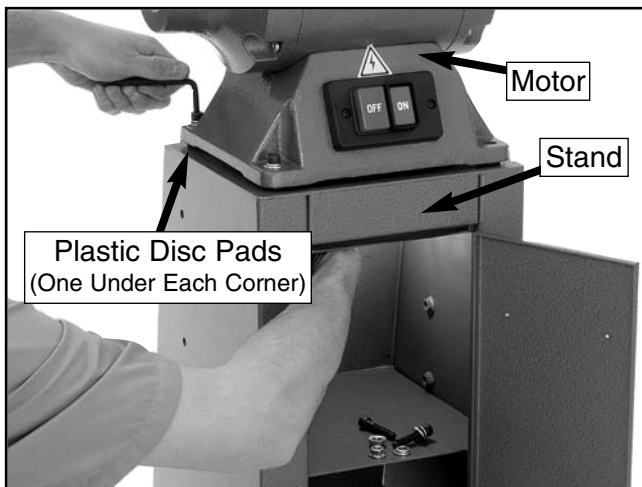

Figure 6. Attaching motor to stand.



Dust Hood Brackets

The two dust hood brackets are identical, but they do not attach to the stand in the same configuration. **Figure 7** shows the correct bracket configuration.

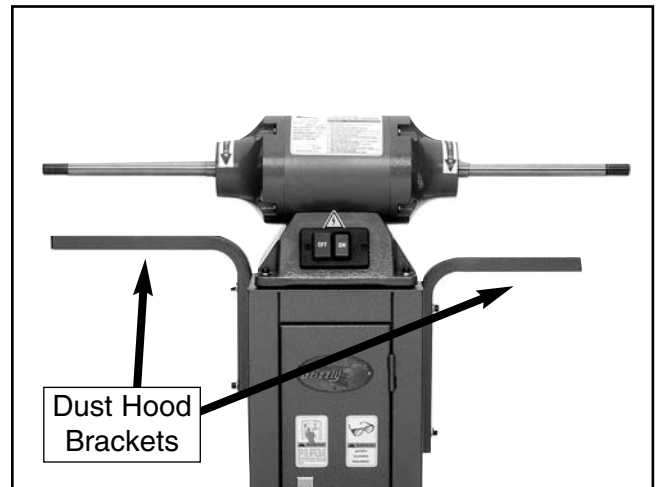

Figure 7. Dust hood bracket configuration (Front View).

To attach the dust hood brackets to the stand:

Attach the dust hood brackets to the stand with (4) M8-1.25 x 40 cap screws, (4) M8 flat washers and (4) M8 lock washers (**Figure 8**).

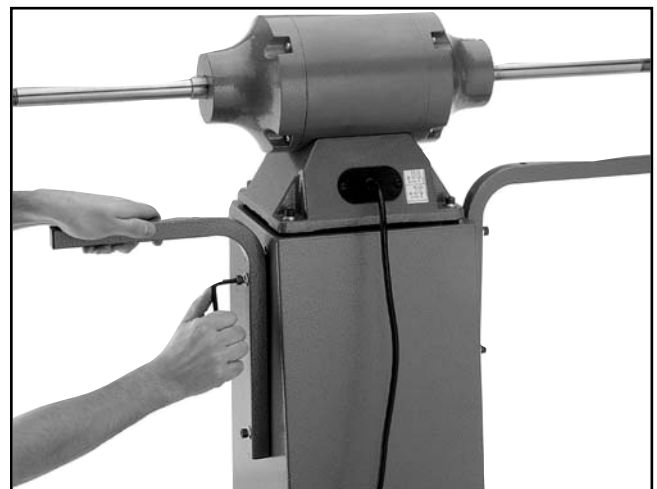

Figure 8. Attaching dust hood brackets to stand (back-side view).



Dust Hoods

To attach the dust hoods to the brackets:

Attach the dust hoods to the brackets with (4) M8-1.25 x 40 cap screws, (4) M8 flat washers and (4) M8 lock washers (**Figure 9**).

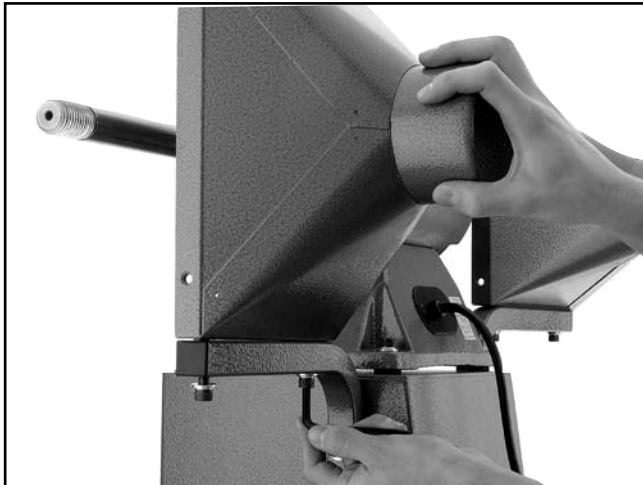

Figure 9. Attaching one of the dust hoods.



Acrylic Eye Shields

To attach the acrylic eye shields to the dust hoods:

Loosely attach the acrylic eye shields to the dust hoods with (4) M8-1.25 x 20 cap screws, (4) M8 flat washers and (4) M8 lock washers (**Figure 10**). Final tighten the cap screws carefully as to not break the acrylic eye shields. Note—*Match the correct acrylic eye shield to each dust hood by aligning the mounting holes.*



Figure 10. Attaching one of the acrylic eye shields.



Sanding Drum

Slide the arbor wrench over the “flat” on the arbor when loosening or tightening the arbor nuts. **Figure 11** shows the location of the arbor “flat.”

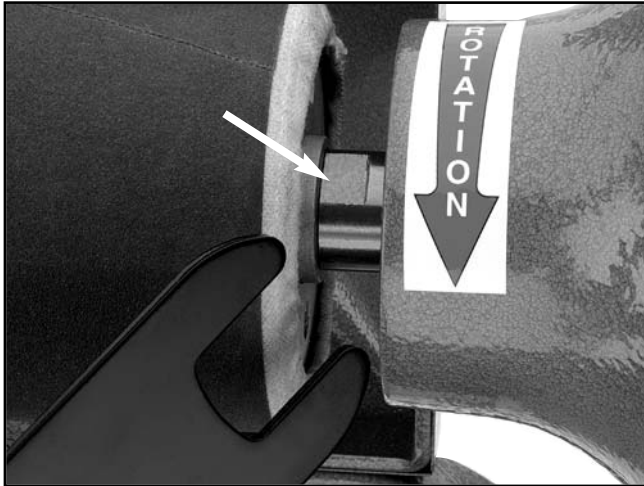

Figure 11. One side of the arbor “flat.”

To attach the sanding drum to the arbor:

1. Slide the sanding drum onto the left-side arbor. Note—*Make sure the air valve on the sanding drum faces away from the motor.*
2. Begin threading the right-hand threaded arbor nut onto the end of the arbor.
3. Using the two arbor wrenches, tighten the arbor nut to secure the sanding drum onto the arbor as shown in **Figure 12**.

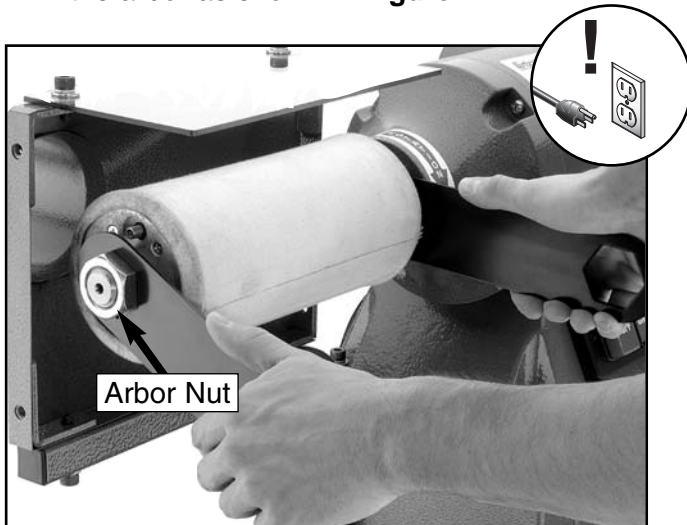

Figure 12. Tightening the sanding drum arbor nut.

4. Slide the sanding sleeve over the sanding drum as shown in **Figure 13**. If there is a directional arrow printed on the inside of an aftermarket sanding sleeve, make sure it matches the rotation direction label on the motor. Note—*The Model G0518 uses 4”D x 9”W sanding sleeves. The Grizzly Catalog offers a wide range of available grits to suite just about any sanding operation.*

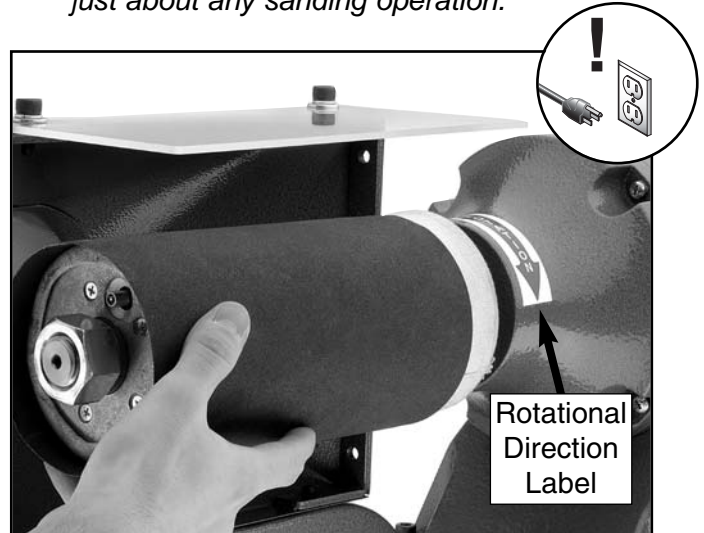

Figure 13. Sliding the sanding sleeve over the sanding drum.

5. Using a hand-operated bicycle tire pump, carefully inflate the sanding drum (**Figure 14**) to a pressure no greater than 10 PSI.



Figure 14. Inflating the sanding drum.



Flap Sander

To attach the flap sander to the arbor:

1. Slide the flap sander onto the right-side arbor as shown in **Figure 15**.



Figure 15. Sliding the flap sander onto the arbor.

2. Slide the flange and the arbor spacer onto the arbor, and begin threading the left-hand threaded arbor nut onto the end of the arbor (**Figure 16**).

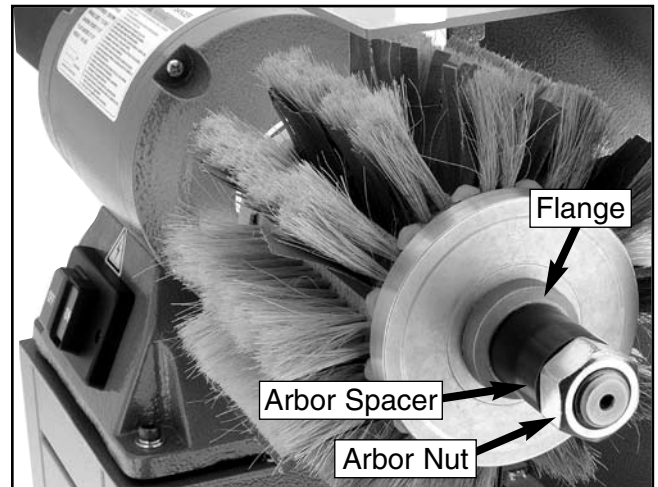

Figure 16. Flap sander with correctly mounted hardware.

- Using the two arbor wrenches, tighten the arbor nut to secure the flap sander onto the arbor as shown in **Figure 17**. Note—Use the arbor “flat” shown in **Figure 11** when using the arbor wrenches to tighten the left-hand threaded arbor nut.

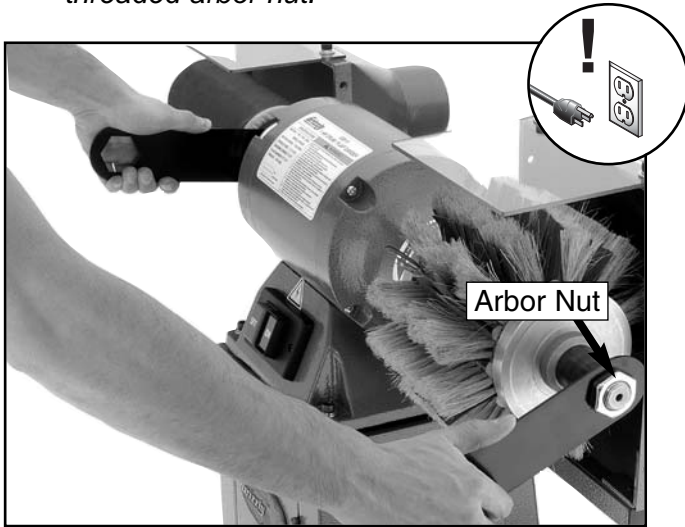

Figure 17. Tightening the flap sander arbor nut.



Dust Collection

To attach dust collection hoses to the dust hoods:

Attach each dust hood to 4" hoses from your dust collection system (**Figure 18**).

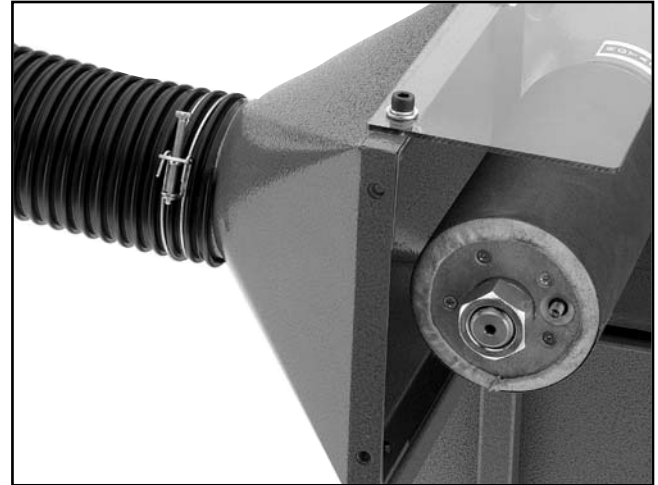

Figure 18. Dust collection hose hook-up.



Start Up

⚠️ WARNING

Serious personal injury could result if the machine is connected to the power source during assembly or adjustment. Wait until the machine is turned off, unplugged and all working parts have come to a complete stop before you attempt to assemble or adjust the machine!

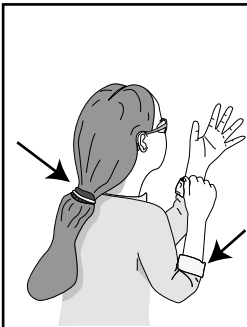

⚠️ WARNING

Loose hair and clothing could get caught in machinery and cause serious personal injury. Keep loose clothing rolled up and long hair tied up and away from machinery.



⚠️ WARNING

Projectiles from the machine could cause serious eye injury. Wear safety glasses at all times.

Before starting the machine:

1. Read this manual and make sure you understand *Section 1: Safety* beginning on **Page 2**.
2. Make sure the acrylic eye shields are installed (**Figure 10**) and are covering the sanding drum and the flap sander.
3. Make sure all tools and foreign objects have been removed from the machine.
4. Review *Section 3: Circuit Requirements* beginning on **Page 6**, and make any necessary changes.

Starting the machine:

1. **Wear safety glasses at all times when running the sander!**
2. Plug the sander into the power source.
3. Push the ON button shown in **Figure 19**. Make sure that your finger is poised on the OFF button, just in case there is a problem. The sander should run smoothly, with little or no vibration or rubbing noises. Strange or unnatural noises should be investigated and corrected before operating the machine further.



Figure 19. Power switch.

If the sander seems to be running correctly, let it run for a short time to ensure that the moving parts are working properly with no excessive vibration. If any problem develops, correct it before attempting to use the machine.

If you cannot locate the source of unusual noises, feel free to contact our service department for help.



SECTION 6: OPERATION

Operation Safety

Your safety is important! Please follow the warnings below during this entire section:

WARNING

To avoid serious personal injury, read and become familiar with the entire instruction manual before using the Model G0518.

WARNING

Damage to your eyes, lungs, and ears could result from failure to wear safety glasses, a dust mask, and hearing protection while sanding with this machine.



WARNING

Loose hair and clothing could get caught in machinery and cause serious personal injury. Keep loose clothing rolled up and long hair tied up and away from machinery.



Choosing Sandpaper

The grit you choose will depend on the type of work, the species of wood and the stage of finishing. Below is a chart that groups sandpaper into different categories and shows which grits fall into each one. We recommend using aluminum oxide sandpaper for best results.

Grit	Type
60	Coarse
80-100	Medium
120-150	Fine

The general rule of thumb is to sand a workpiece with progressively higher grit numbers, with no one grit increase of more than 50; however, the type of wood you use and your stage of finish will determine the best grit types to install on your sander.



Drum Sanding

To correctly perform a drum sanding operation:

1. **Unplug the machine from the power source!**
2. If not already installed, mount the desired sanding sleeve over the sanding drum as described on **Page 17, Step 4-5**.
3. Using a hand-operated bicycle tire pump, carefully inflate the air bladder of the sanding drum to no more than 10 PSI. Check the PSI setting with a pressure gauge to make sure you do not over-inflate the air bladder (**Figure 20**). *Note—Experiment with different PSI settings to achieve the desired sanding drum performance.*

CAUTION

Inflating the drum sander over 10 PSI can damage the air bladder. Use a hand-operated bicycle tire pump when inflating and use a pressure gauge to ensure the air bladder is not inflated over to over 10 PSI.



Figure 20. Checking air pressure.

4. **Wear safety glasses, a dust mask and hearing protection at all times when operating the sander.**
5. Plug the machine into the power source, press the ON switch and wait for the sander to reach full speed.
6. Once the sander has reached full speed, you can begin sanding the workpiece (**Figure 21**). *Note—Move the workpiece back and forth across the entire sanding sleeve surface to ensure maximum sanding sleeve life and to achieve the best finish results.*

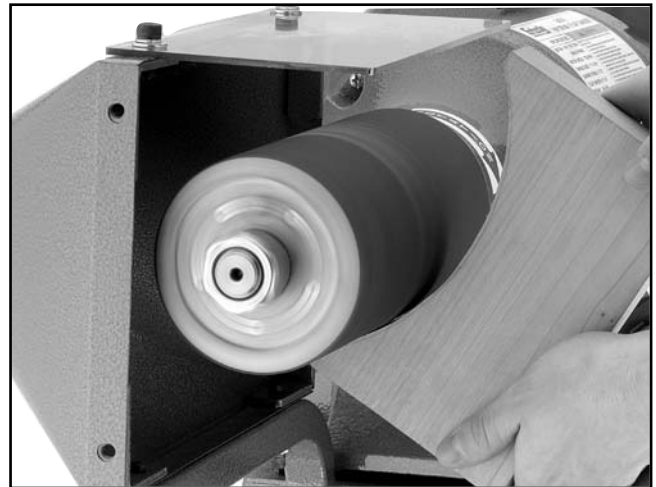

Figure 21. Drum sanding.



Flap Sanding

To correctly perform a flap sanding operation:

1. **Unplug the machine from the power source!**
2. If not already installed, mount the flap sander as described on **Page 18-19**. When attached correctly, the flap sander should resemble **Figure 22**.



Figure 22. Correctly installed flap sander.

3. **Wear safety glasses, a dust mask and hearing protection at all times when operating the sander.**
4. Plug the machine into the power source, press the ON switch and wait for the sander to reach full speed.
5. Once the sander has reached full speed, you can begin sanding the workpiece (**Figure 23**). Note—*Move the workpiece back and forth across the entire sanding surface to ensure maximum sanding surface life and to achieve the best finish results.*



Figure 23. Flap sanding.



SECTION 7: MAINTENANCE

Maintenance Safety

Your safety is important! Please follow the warnings below during this entire section:

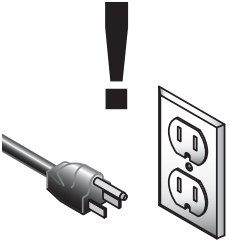
	<p>! WARNING Serious personal injury could occur if you connect your machine to the power source during the maintenance process. DO NOT connect the machine to the power source while performing any maintenance on the Model H3118.</p>
---	--

	<p>! WARNING Loose hair and clothing could get caught in machinery and cause serious personal injury. Keep loose clothing rolled up and long hair tied up and away from machinery.</p>
---	---

	<p>! WARNING Projectiles from the machine could cause serious eye injury. Wear safety glasses at all times.</p>
---	--



General

Regular periodic maintenance on your Model G0518 will ensure its optimum performance. Make a habit of inspecting your machine each time you use it.

Before each use, perform the following checks:

- Tighten loose fasteners and hardware.
- Make sure the ON/OFF switch functions correctly. If it is not functioning correctly, replace it. **DO NOT** try to repair a malfunctioning switch.
- Remove accumulations of sawdust from the machine to allow adequate heat dissipation.
- Replace worn or damaged sanding sleeves, sanding flaps, and sanding brushes.
- Correct any other condition that could inhibit the safe operation of this machine.



SECTION 8: SERVICE ADJUSTMENTS

Flap Sander

The flap sander is comprised of many pieces. When the sanding surfaces of the flap sander begin to wear, they can be adjusted to reveal a fresh sanding surface. **Figure 24** shows the components of the flap sander.

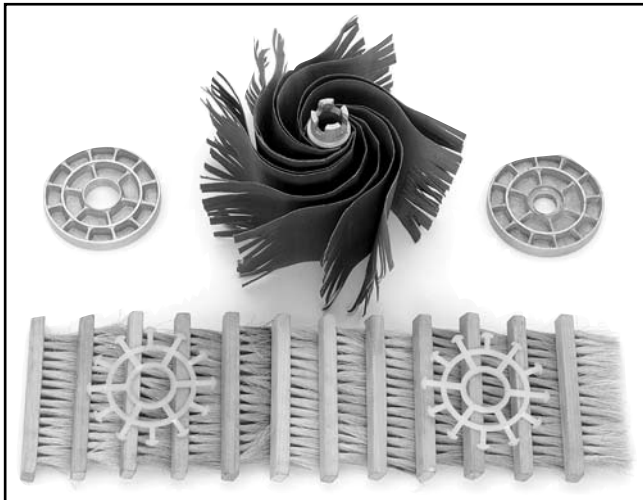

Figure 24. Flap sander components.

To reveal fresh sanding surfaces on the flap sander:

1. **Unplug the machine from the power source!**
2. Loosen the arbor nut that secures the flap sander to the arbor.
3. Remove the flap sander from the arbor and disassemble it down to the components shown in **Figure 24**.
4. Using scissors or tin snips, cut off the worn portion of the sandpaper from every flap. *Note—Every flap must be the same length after they have been cut.*
5. Cut approximately (15) 2" slits into the end of each flap.
6. Begin to re-assemble the flap sander as shown in **Figure 25**, until fully assembled.



Figure 25. Re-assembling the flap sander.

Periodically the sandpaper flaps and brushes will need to be replaced. Brush sets (Model H2491) can be ordered from the Grizzly Catalog, as well as various grits of 6" wide sandpaper rolls.

To replace the sandpaper flaps:

1. Once disassembled, remove the clamps that secure the sandpaper flaps to the center post (**Figure 26**).



Figure 26. Removing sandpaper clamps.

2. Cut new 6" wide sandpaper flaps to 12" long.
3. Using the clamps, attach the new sandpaper to the center post in groups of two per clamp.
4. Cut the sandpaper slits and re-assemble as described earlier on this page.



Changing Motor Voltage

The Model G0518 comes from the factory prewired to operate at 110V. The motor can also be wired to operate at 220V. Before changing the running voltage to 220V, review **Page 7** and make sure you have a suitable 220V power source.

To change the running voltage:

1. **Unplug the machine from the power source!**
2. Remove the 4 bolts that secure the motor assembly to the stand.
3. Carefully lift the motor assembly from the stand and lay it on its side to reveal the electrical wires shown in **Figure 27**.

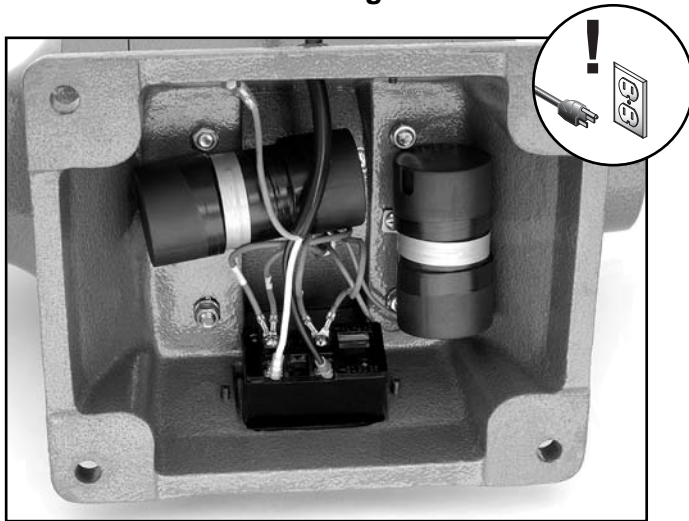

Figure 27. G0518 Wiring.

4. Follow the wiring diagram in **Figure 28** to wire the Model G0518 for 110V.

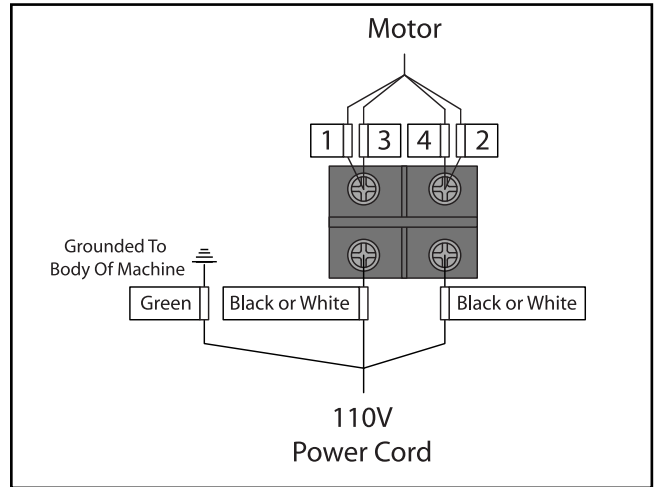

Figure 28. G0518 110V wiring.

5. Follow the wiring diagram in **Figure 29** to wire the Model G0518 for 220V.

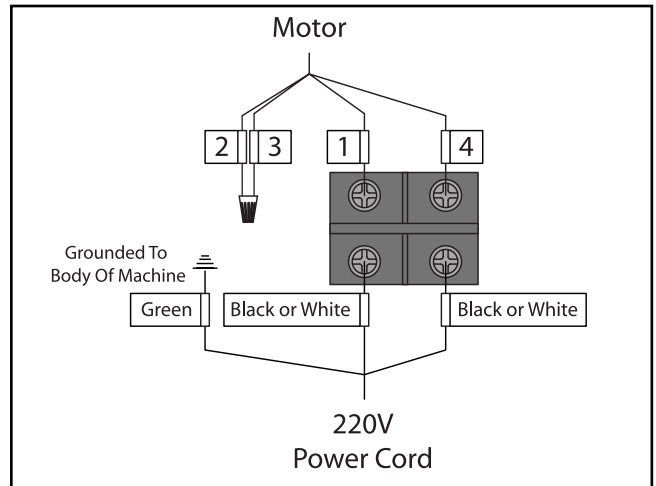

Figure 29. G0518 220V wiring.

6. Re-assemble the machine when finished.



SECTION 9: REFERENCE INFO

If you need parts or help in assembling your machine, or if you need operational information, please call the Grizzly Service Department. Our trained service technicians will be glad to help you.

If you have any comments regarding this manual, please write to Grizzly at the address below:

Grizzly Industrial, Inc.
c/o Technical Documentation
P.O. Box 2069
Bellingham, WA 98227-2069

Important safety measures that are essential to the operation of this machine have been explained in *Section 1: Safety*. While most safety measures are generally universal, Grizzly reminds you that each workshop is different and safety rules should be considered as they apply to your specific situation.

We recommend you keep a copy of our current catalog for complete information regarding Grizzly's warranty and return policy. If you need additional technical information relating to this machine, or if you need general assistance or replacement parts, please contact the Service Department at the location listed below.

Grizzly Industrial, Inc.
1203 Lycoming Circle
Muncy, PA 17756
Phone: (570) 546-9663
Fax: (800) 438-5901
E-Mail: techsupport@grizzly.com
Web Site: <http://www.grizzly.com>.

Additional information sources are necessary to realize the full potential of this machine. Trade journals, woodworking magazines, and your local library are good places to start.





MACHINE DATA SHEET

Customer Service #: (570) 546-9663 • To Order Call: (800) 523-4777 • Fax #: (800) 438-5901

MODEL G0518 DRUM / FLAP SANDER

Design TypeFloor Model

Overall Dimensions:

Height40"
 Width38"
 Depth19³/₄"
 Shaft Height.....34"
 Stand Height.....26¹/₂"
 Stand Footprint.....19³/₄" x 19³/₄"
 Weight (Net)144 lbs.
 Weight (Shipping).....155 lbs.
 Box 1 Size40⁹/₈" x 14" x 14"
 Box 2 Size25¹/₂" x 13⁷/₈" x 11"
 Box 3 Size20¹/₂" x 20¹/₂" x 2⁵/₈"

Capacities:

Arbor Size1" x 10¹/₂"
 Pneumatic Drum 4" x 9"1800 FPM

Construction:

Motor BaseCast Iron
 BodyCast Iron
 Stand.....Preformed Steel

Motor:

TypeTEFC Capacitor Start Induction
 Horsepower.....1 HP
 Phase / HertzSingle-Phase / 60Hz
 Voltage110V / 220V
 Amps.....12A / 6A
 RPM1725
 Bearings.....62606ZZ Shielded and Lubricated Ball Bearings
 SwitchON/OFF Push Button

Features:

.....(1) 4" x 9" Sanding Drum
(1) 9" x 6" Flap Sander
Safety Eye shields
(2) 4" Dust Ports
Included Arbor Wrench

Specifications, while deemed accurate, are not guaranteed.

PARTS DIAGRAMS AND LISTS

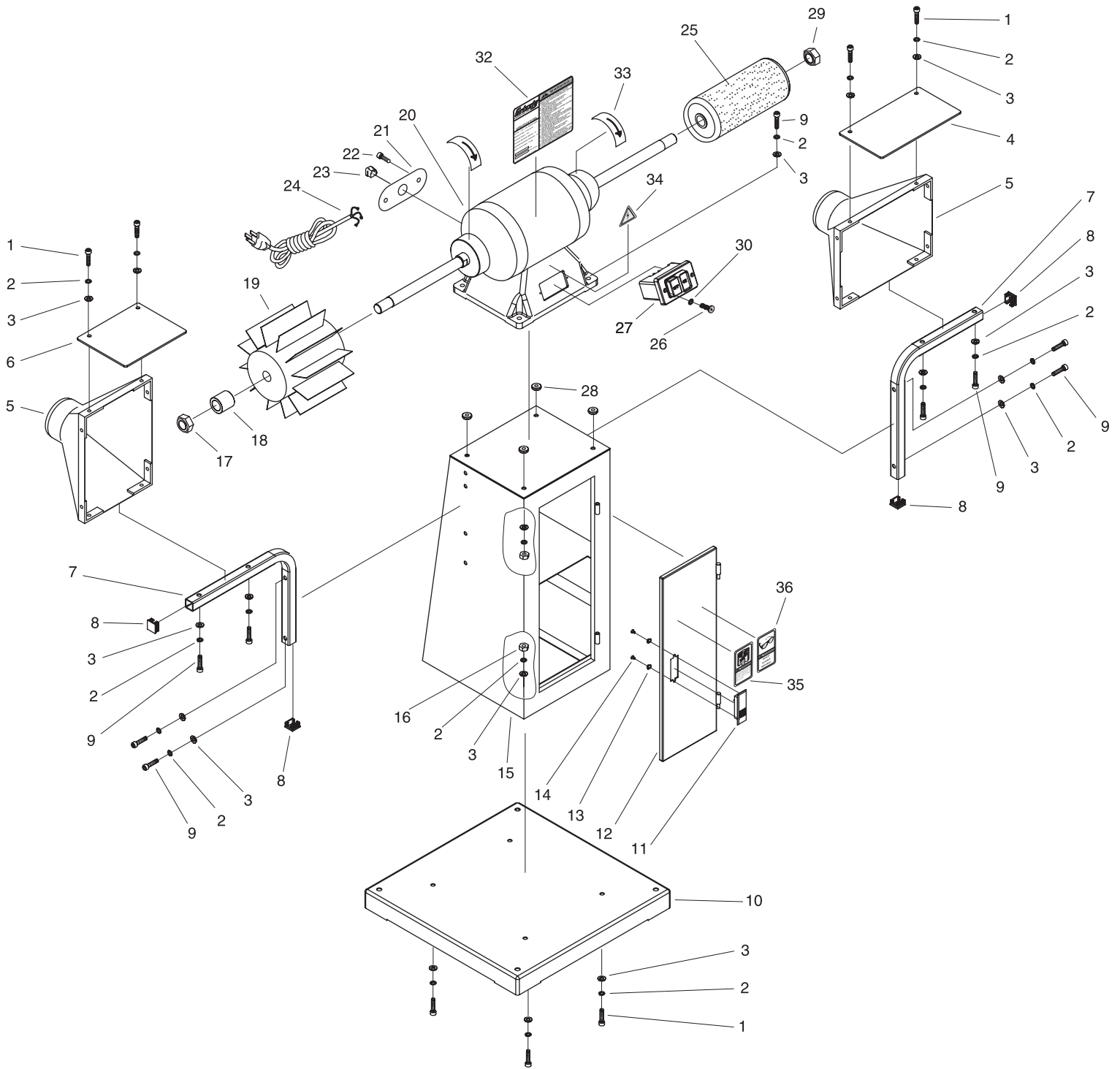

REF	PART #	DESCRIPTION
1	PSB14M	CAP SCREW M8-1.25 X 20
2	PLW04M	LOCK WASHER 8MM
3	PW01M	FLAT WASHER 8MM
4	P0518004	ACRYLIC EYE SHIELD
5	P0518005	DUST HOOD
6	P0518006	ACRYLIC EYE SHIELD
7	P0518007	DUST HOOD BRACKET
8	P0518008	PLUG
9	PSB12M	CAP SCREW M8-1.25 X 40
10	P0518010	BASE
11	P0518011	DOOR LATCH ASSEMBLY
12	P0518012	DOOR COVER
13	PW05M	FLAT WASHER 4MM
14	PS17M	PHLP HD SCR M4-0.7 X 6
15	P0518015	STAND
16	PFN01M	HEX FLANGE NUT M8-1.25
17	PN22	HEX NUT 1"-8
18	P0518018	BUSHING

REF	PART #	DESCRIPTION
19	P0518019	BRUSH
20	P0518020	1 HP MOTOR
21	P0518021	PLATE
22	PS08M	PHLP HD SCR M5-0.8 X 12
23	P0518023	STRAIN RELIEF
24	PWRCRD110L	POWER CORD 110V
25	P0518025	SANDING DRUM
26	PS06M	PHLP HD SCR M5-0.8 X 20
27	P0518027	POWER SWITCH
28	P0518028	PLASTIC DISC PAD
29	PN18	HEX NUT 1"-8 LH
30	PLW01M	LOCK WASHER 5MM
31	P0518031	FOAM
32	P0518032	MACHINE ID LABEL
33	P0518033	ROTATION LABEL
34	PLABEL-14	ELECTRICITY LABEL
35	PLABEL-12	READ MANUAL LABEL
36	PLABEL-11	SAFETY GLASSES LABEL

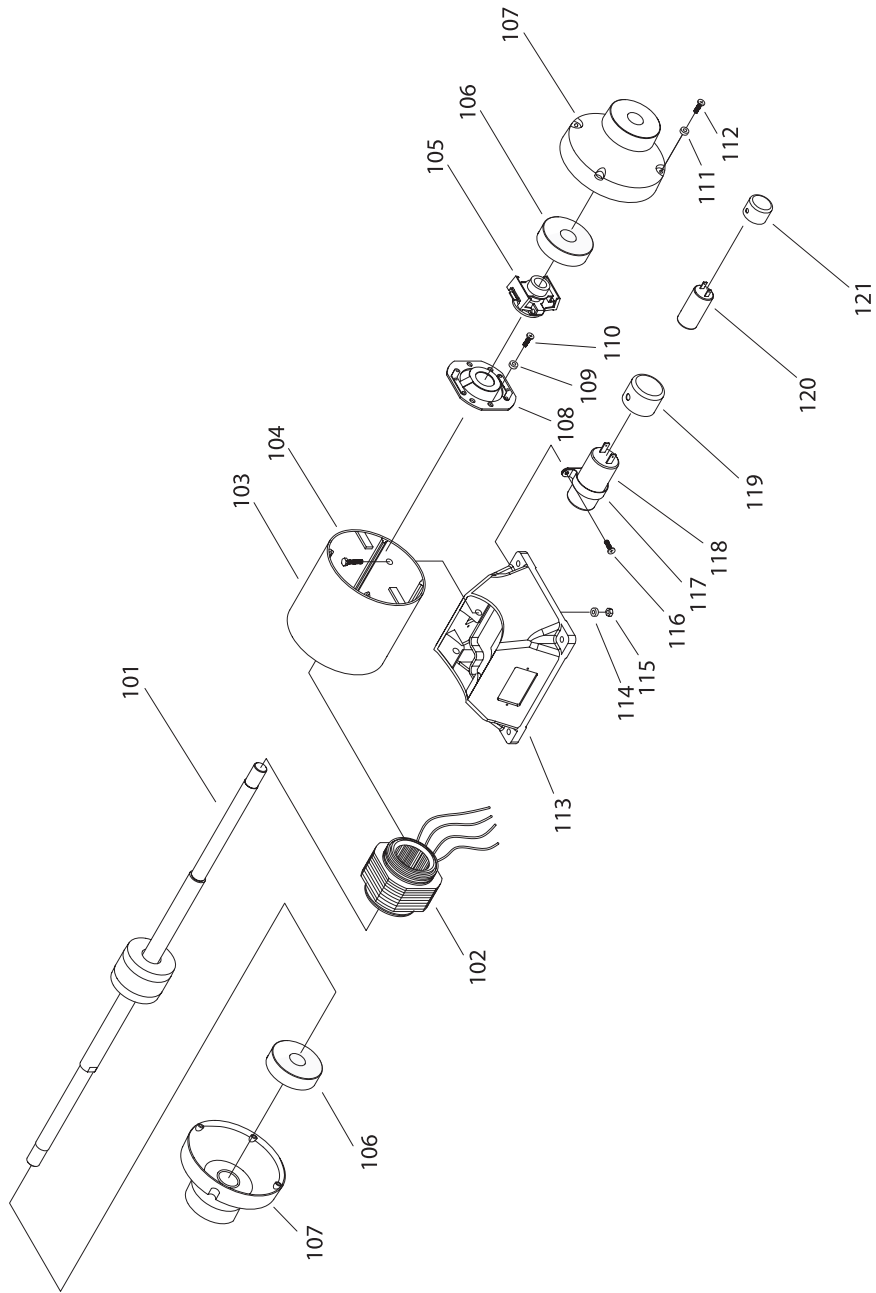

REF	PART #	DESCRIPTION
101	P0518101	MOTOR SHAFT
102	P0518102	STATOR WINDING
103	P0518103	MOTOR BODY
104	PB09M	HEX BOLT M8-1.25 X 20
105	P0518105	CENTRIFUGAL SWITCH
106	P6206	BALL BEARING 6206
107	P0518107	MOTOR COVER
108	P0518108	SPRING PLATE
109	PLW01M	LOCK WASHER 5MM
110	PS18	PHLP HD SCR #10-24 X 1/4
111	PLW03M	LOCK WASHER 6MM

REF	PART #	DESCRIPTION
112	PS35	PHLP HD SCR 5/16" X 3/4"
113	P0518113	MOTOR BASE
114	PLW04M	LOCK WASHER 8MM
115	P0518115	HEX NUT M8-1.25
116	PS18	PHLP HD SCR #10-24 X 1/4
117	P0518117	CAPACITOR CLAMP
118	P0518118	CAPACITOR
119	P0518119	CAPACITOR COVER
120	P0518120	CAPACITOR
121	P0518121	CAPACITOR COVER
122	P0518122	CAPACITOR CLAMP

Aftermarket Accessories

The following aftermarket accessories can be ordered from the Grizzly Catalog by calling 1-800-523-4777, or by visiting www.grizzly.com.

Sanding Sleeves (4" Dia. Aluminum Oxide)

DESC.	MODEL
60 Gr.	H5010
80 Gr.	H5011
100 Gr.	H5012
120 Gr.	H5013
150 Gr.	H5014
180 Gr.	H5015

Replacement Flap Brushes

DESC.	MODEL
Set Of 12	H2491

Sandpaper Rolls (6" x 60", J Weight, Aluminum Oxide)

DESC.	MODEL
120 Gr.	G9187
180 Gr.	G9188
220 Gr.	G9189

Sandpaper Cleaning Sticks

DESC.	MODEL
1½" x 1½" x 8½"	G1511
2" X 2" X 12"	G1512

Dust Collection Accessories

DESC.	MODEL
4" x 10' Flexible Hose	G1536
4" Wire Hose Clamp.....	G2974

WARRANTY AND RETURNS

Grizzly Industrial, Inc. warrants every product it sells for a period of **1 year** to the original purchaser from the date of purchase. This warranty does not apply to defects due directly or indirectly to misuse, abuse, negligence, accidents, repairs or alterations or lack of maintenance. This is Grizzly's sole written warranty and any and all warranties that may be implied by law, including any merchantability or fitness, for any particular purpose, are hereby limited to the duration of this written warranty. We do not warrant or represent that the merchandise complies with the provisions of any law or acts unless the manufacturer so warrants. In no event shall Grizzly's liability under this warranty exceed the purchase price paid for the product and any legal actions brought against Grizzly shall be tried in the State of Washington, County of Whatcom.

We shall in no event be liable for death, injuries to persons or property or for incidental, contingent, special, or consequential damages arising from the use of our products.

To take advantage of this warranty, contact us by mail or phone and give us all the details. We will then issue you a "Return Number," which must be clearly posted on the outside as well as the inside of the carton. We will not accept any item back without this number. Proof of purchase must accompany the merchandise.

The manufacturers reserve the right to change specifications at any time because they constantly strive to achieve better quality equipment. We make every effort to ensure that our products meet high quality and durability standards and we hope you never need to use this warranty.

Please feel free to write or call us if you have any questions about the machine or the manual.

Thank you again for your business and continued support. We hope to serve you again soon.

WARRANTY CARD

Name _____
Street _____
City _____ State _____ Zip _____
Phone Number _____ E-Mail _____ FAX _____
MODEL # _____ Order # _____ Serial # _____

The following information is given on a voluntary basis. It will be used for marketing purposes to help us develop better products and services. Of course, all information is strictly confidential.

- How did you learn about us?
 Advertisement Friend
 Catalog Card Deck
 World Wide Web

 Other _____
- Which of the following magazines do you subscribe to.
 American Woodworker Practical Homeowner
 Cabinetmaker Shop Notes
 Family Handyman Today's Homeowner
 Fine Homebuilding WOOD
 Fine Woodworking Wooden Boat
 Home Handyman Woodshop News
 Journal of Light Construction Woodsmith
 Old House Journal Woodwork
 Popular Mechanics Woodworker
 Popular Science Woodworker's Journal
 Popular Woodworking Workbench

 Other _____
- Which of the following woodworking/remodeling shows do you watch?
 Backyard America The New Yankee Workshop
 Home Time This Old House
 The American Woodworker Woodwright's Shop

 Other _____
- What is your annual household income?
 \$20,000-\$29,999 \$60,000-\$69,999
 \$30,000-\$39,999 \$70,000-\$79,999
 \$40,000-\$49,999 \$80,000-\$89,999
 \$50,000-\$59,999 \$90,000 +
- What is your age group?
 20-29 50-59
 30-39 60-69
 40-49 70 +
- How long have you been a woodworker?
 0 - 2 Years 8 - 20 Years
 2 - 8 Years 20+ Years
- How would you rank your woodworking skills?
 Simple Advanced
 Intermediate Master Craftsman
- What stationary woodworking tools do you own? Check all that apply.
 Air Compressor Panel Saw
 Band Saw Planer
 Drill Press Power Feeder
 Drum Sander Radial Arm Saw
 Dust Collector Shaper
 Horizontal Boring Machine Spindle Sander
 Jointer Table Saw
 Lathe Vacuum Veneer Press
 Mortiser Wide Belt Sander

 Other _____
- How many of your woodworking machines are Grizzly? _____
- Which benchtop tools do you own? Check all that apply.
 1" x 42" Belt Sander 6" - 8" Grinder
 5" - 8" Drill Press Mini Lathe
 8" Table Saw 10" - 12" Thickness Planer
 8" - 10" Bandsaw Scroll Saw
 Disc/Belt Sander Spindle/Belt Sander

 Other _____
- How many of the machines checked above are Grizzly? _____
- Which portable/hand held power tools do you own? Check all that apply.
 Belt Sander Orbital Sander
 Biscuit Joiner Palm Sander
 Circular Saw Portable Planer
 Detail Sander Saber Saw
 Drill/Driver Reciprocating Saw
 Miter Saw Router

 Other _____
- What machines/supplies would you like Grizzly Industrial to carry?

- What new accessories would you like Grizzly Industrial to carry?

- What other companies do you purchase your tools and supplies from?

- Do you think your purchase represents good value?
 Yes No
- Would you recommend Grizzly Industrial to a friend?
 Yes No
- Would you allow us to use your name as a reference for Grizzly customers in your area? **Note: We never use names more than three times.**
 Yes No
- Comments: _____

CUT ALONG DOTTED LINE

FOLD ALONG DOTTED LINE



Place
Stamp
Here



GRIZZLY INDUSTRIAL, INC.
P.O. BOX 2069
BELLINGHAM, WA 98227-2069



FOLD ALONG DOTTED LINE

Send a Grizzly Catalog to a friend:

Name _____

Street _____

City _____ State _____ Zip _____

TAPE ALONG EDGES--PLEASE DO NOT STAPLE

grizzly.com

TOOL WEBSITE

Buy Direct and Save with Grizzly® – Trusted, Proven and a Great Value!

*Visit Our Website Today And Discover Why
Grizzly® Is The Industry Leader!*

- SECURE ORDERING
- ORDERS SHIPPED WITHIN 24 HOURS
- E-MAIL RESPONSE WITHIN ONE HOUR

-OR-

Call Today For A **FREE**
Full Color Catalog

1-800-523-4777

